

# Technical data sheet

## Beam clamp, vertical, A2

Item number: 6003952



Beam clamp for mounting light components on vertical steel beams. Suitable, for example, for mesh cable trays and cable trays to 300 mm width or clips. The direction of the cable support system attached to the beam clamp is vertical.

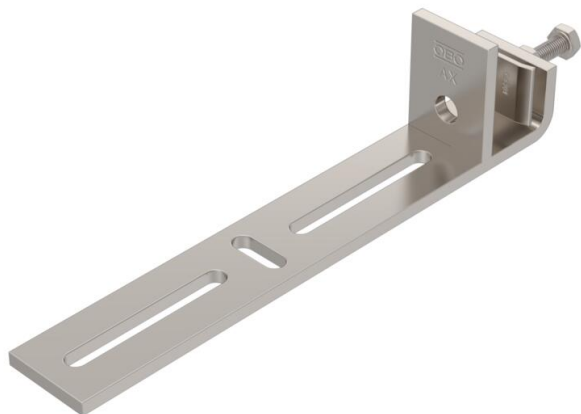

**A2** Stainless steel

**2B** Bright, treated

### Master data

Item number	6003952
Type	BFK S 200 A2
Description 1	Clamping piece
Description 2	for vertical application
Available from	01.03.2026
Manufacturer	OBO
Dimension	254x58x40
Colour	stainless steel
Material	Stainless steel 1.4301
Surface	Bright, treated
Surface standard	
Smallest sales unit	10
Unit of quantity	Piece
Weight	60.92 kg
Weight unit	kg/100 pc.

# Technical data sheet

## Beam clamp, vertical, A2

Item number: 6003952



### Dimensions

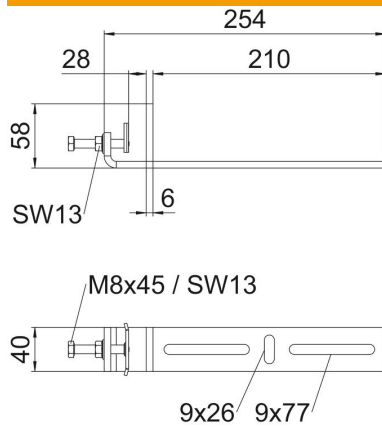

Length	248 mm
Width	210 mm
Height	58 mm

### Technical data

Material thickness	6 mm
Rustproof steel, pickled	yes
Permitted temperature range, max.	120 °C
Permitted temperature range, min.	-20 °C