

Technical data sheet

45° bend 35 FT

Item number: 7065213

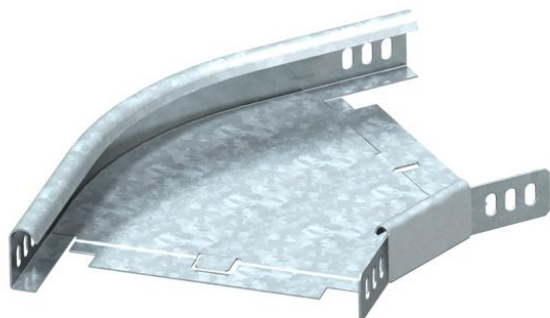

45° bend, horizontal, for all cable tray types of 35 mm side height.
The WKV 35 angle connector is designed for 90° bends and can be adjusted to 45° on site. The fitting is shipped in an unmounted state.
Including appropriate fastening material.



St Steel

FT Hot-dip galvanised

Master data

Item number	7065213
Type	RB 45 320 FT
Description 1	45° bend
Description 2	horizontal + angle connector
Manufacturer	OBO
Dimension	35x200
Material	Steel
Surface	Hot-dip galvanised
Surface standard	DIN EN ISO 1461
Smallest sales unit	1
Unit of quantity	Piece
Weight	65 kg
Weight unit	kg/100 pc.

Technical data sheet

45° bend 35 FT

Item number: 7065213



Dimensions

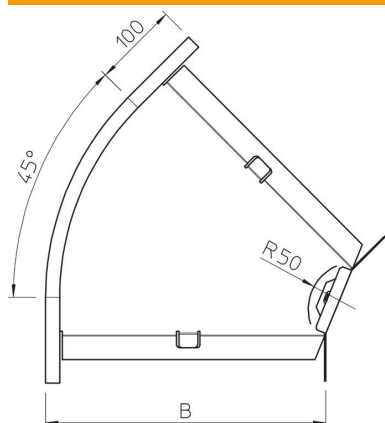

Width	200 mm
Width	8 in
Height	35 mm
Height	1 in
Dimension B	200 mm
Dimension R	50 mm

Technical data

Bend (angle)	45°
Connector version	Supplied connectors
Type	Bend, rigid
Maintain electrical functions	no
Mounting perforation in base	no
NATO hole pattern	no
Change of direction	Horizontal
Rustproof steel, pickled	no
Side perforation	no
Permitted temperature range, max.	120 °C
Permitted temperature range, min.	-20 °C
Wide-span version	no
Type of connector, cable support system	Screwed