

Technical data sheet

Heavy-duty frame cassette for tube body, RKFSL, nominal size 250-3

Item number: 7409522



Heavy-duty frame cassette for tube body for the installation of accessories in the UZD250-3 in dry or wet-cleaned floors for indoor use. Load class 2 to 20 kN.

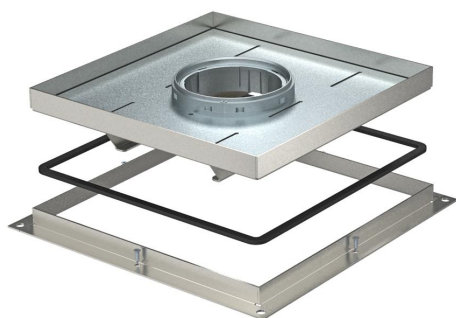

VA Stainless steel, grade 354/1

Master data

Item number	7409522
Type	RKF2 SL2 V2 20
Description 1	Heavy-duty frame cassette
Description 2	for tube
Manufacturer	OBO
Dimension	283x283x20
Material	Stainless steel, grade 354/1
Smallest sales unit	1
Unit of quantity	Piece
Weight	700 kg
Weight unit	kg/100 pc.

Technical data sheet

Heavy-duty frame cassette for tube body, RKFSL, nominal size 250-3

Item number: 7409522



Dimensions

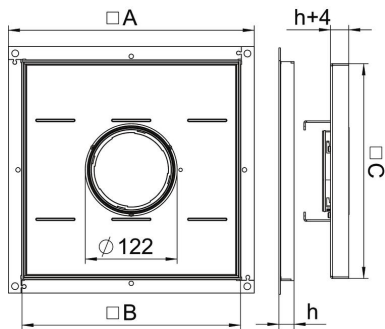

Dimension A	324 mm
Dimension B	288 mm
Dimension C	282 mm
Dimension h	20 mm

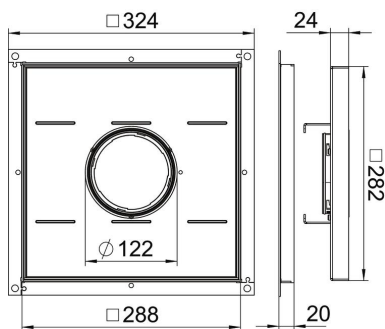

Technical data

Cable outlet version	Lowerable tube body
Suitable for raised floor installation	yes
Suitable for cavity floor installation	yes
Suitable for	Underfloor socket structure
Suitable for underfloor box	250
Length of installation dimensions	290 mm
Protection rating (IP) when used	IP20
Protection rating (IP) when unused	IP44
Protection rating IK code	IK10
Heavy-duty version	yes
Heavy load class	20 kN (OBO SL2)