

# Technical data sheet

Height-adjustable heavy-duty cassette for tube body RK-FRSL, nominal size R4, stainless steel  
Item number: 7409464



Round heavy-duty cassette for tube body of nominal size R4 for the installation of accessories in trunking systems, raised and cavity floors, in dry or wet-cleaned floors indoors. Load class 2 to 20 kN.

Height-adjustable heavy-duty cassette with tube body with a load bearing capacity of 2–20 kN, 2-compartment. 2 APMT2 cover plates can be installed. For the installation of 2 UT3 universal supports for 4 individual installation devices with support ring/support clamp or 6 Modul 45 devices.



VA

Stainless steel, grade 354/1

## Master data

Item number	7409464
Type	RKFR2 4 SL2V2 25
Description 1	Heavy-duty cassette
Description 2	for tube, 20 kN
Manufacturer	OBO
Dimension	Ø215mm
Material	Stainless steel, grade 354/1
Smallest sales unit	1
Unit of quantity	Piece
Weight	669 kg
Weight unit	kg/100 pc.

# Technical data sheet

Height-adjustable heavy-duty cassette for tube body RK-FRSL, nominal size R4, stainless steel  
Item number: 7409464



## Dimensions

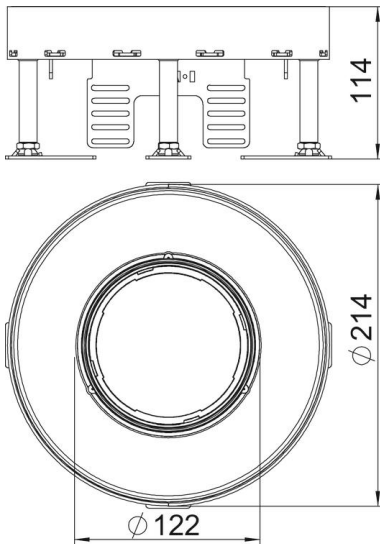

Dimension h 114 mm

## Technical data

Number of installable devices	6
Number of mounting boxes	2
Number of cable outlets	1
Version for	Round
Cable outlet version	Lowerable tube body
Floor care	Wet
Decouplable	no
Floor height, max.	159 mm
Floor height, min.	114 mm
Suitable for raised floor installation	yes
Suitable for cavity floor installation	yes
Suitable for underfloor box	250/350
Device support to accept mounting boxes	yes
Nominal size for device installation units	R4
Height-adjustment range, max.	159 mm
Height-adjustment range, min.	114 mm
Protection rating (IP) when used	IP20
Protection rating (IP) when unused	IP44
Protection rating IK code	IK10
Heavy-duty version	yes
Heavy load class	20 kN (OBO SL2)
Installation system type	UT3