

Technical data sheet

90° bend with trapezoidal rung, light-duty FT

Item number: 7098626



90° bend for shipbuilding cable ladders, type SL 42, with a side height of 25 mm with welded, perforated trapezoidal rungs which open in a downwards direction. Connectors should be ordered separately and in the appropriate quantity.

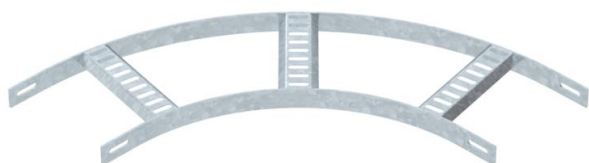

St Steel

FT Hot-dip galvanised

Master data

Item number	7098626
Type	SLB 90 42 150 FT
Description 1	90° bend
Description 2	with trapezoidal rung
Manufacturer	OBO
Dimension	B156mm
Material	Steel
Surface	Hot-dip galvanised
Surface standard	DIN EN ISO 1461
Smallest sales unit	1
Unit of quantity	Piece
Weight	88.9 kg
Weight unit	kg/100 pc.

Technical data sheet

90° bend with trapezoidal rung, light-duty FT

Item number: 7098626



Dimensions

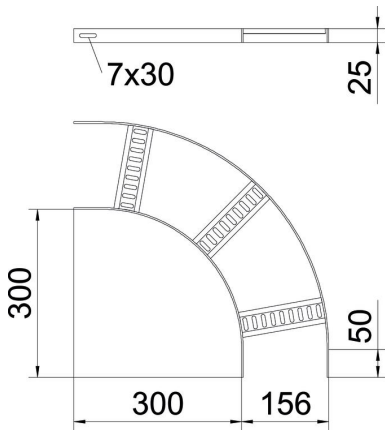

Width	150 mm
Height	25 mm

Technical data

Bend (angle)	90°
Version of the rungs	Profile perforated
Side rail version	Flat profile
Connector version	Without connectors
Maintain electrical functions	no
Change of direction	Horizontal
Rustproof steel, pickled	no
Hinged	no
Side perforation	no
Wide-span version	no