

Technical data sheet

90° bend with trapezoidal rung, ALU

Item number: 7099188



90° bend for shipbuilding cable ladders, type SL 62, with side height of 40 mm with welded, perforated trapezoidal rungs which open in a downwards direction. Connectors should be ordered separately and in the appropriate quantity.



Alu Aluminium

GB Pickled

Master data

Item number	7099188
Type	SLB 90 62 200ALU
Description 1	90° bend
Description 2	with trapezoidal rung
Manufacturer	OBO
Dimension	B210mm
Material	Aluminium
Surface	Pickled
Surface standard	
Smallest sales unit	1
Unit of quantity	Piece
Weight	88.1 kg
Weight unit	kg/100 pc.

Technical data sheet

90° bend with trapezoidal rung, ALU

Item number: 7099188



Dimensions

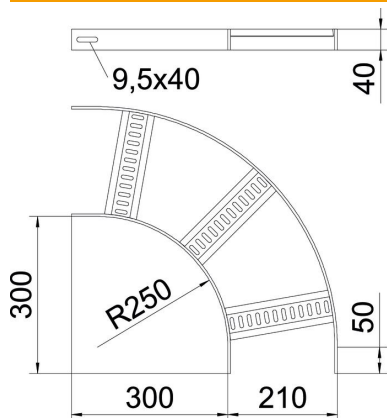

Width	200 mm
Height	40 mm

Technical data

Bend (angle)	90°
Version of the rungs	Profile perforated
Side rail version	Flat profile
Connector version	Without connectors
Maintain electrical functions	no
Change of direction	Horizontal
Rustproof steel, pickled	yes
Hinged	no
Side perforation	no
Wide-span version	no