

Technical data sheet

Cable ladder with Z rung, light duty

Item number: 7098042

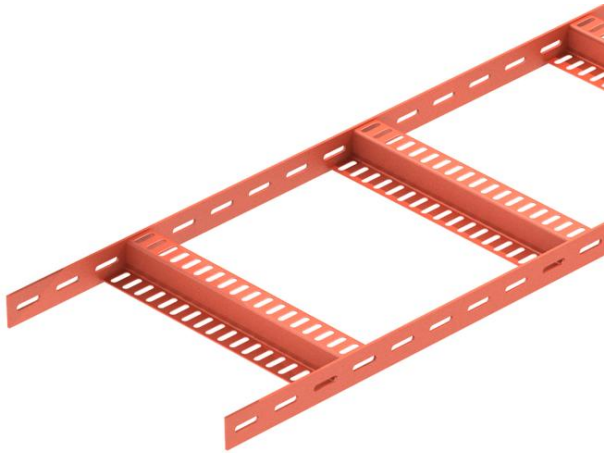

Light-duty shipbuilding cable ladder with perforated side rail of side height 35 mm with welded, perforated Z rungs. Load tested according to IEC in conjunction with connector, type SLV. Welding primer type SIGMA-WELD 199, also available in white.

The shipbuilding cable ladder, including fittings, is also available in stainless steel on request. Powder coating according to RAL colours possible.



St Steel

SG Welding primed

Master data

Item number	7098042
Type	SLZ L 500 SG
Description 1	Cable ladder, shipbuilding
Description 2	with Z-rung
Manufacturer	OBO
Dimension	35x506x3000
Material	Steel
Surface	Welding primed
Surface standard	
Smallest sales unit	3
Unit of quantity	Metre
Weight	250 kg
Weight unit	kg/100 m

Technical data sheet

Cable ladder with Z rung, light duty

Item number: 7098042



Dimensions

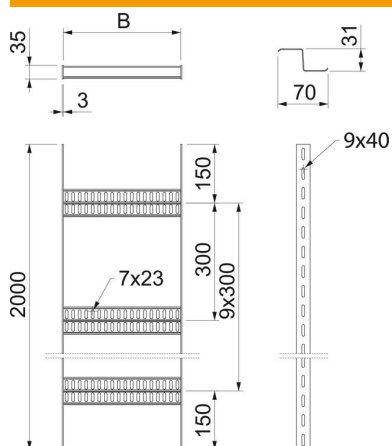

Dimension	35x500
Length	3,000 mm
Length	3,000 ft
Width	500 mm
Height	35 mm
Dimension B	506 mm

Technical data

Version of the rungs	Profile perforated
Side rail version	Flat profile
Fastening of rung	Welded
Maintain electrical functions	no
Rustproof steel, pickled	no
Side perforation	yes
Rung distance	300 mm
Wide-span version	no
Rail thickness	3 mm

Loads

Support spacing 1.5 m	1.5 kN/m
Support spacing 2.0 m	0.85 kN/m
Support spacing 2.5 m	0.35 kN/m
Support spacing 3.0 m	0.25 kN/m

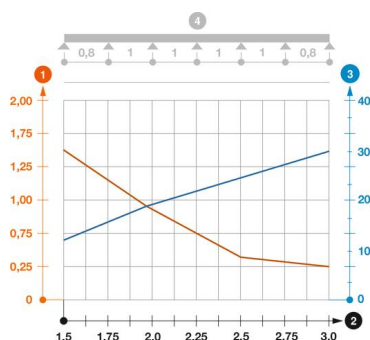

Load diagram, cable ladder, type SLZ L

- 1 Permitted cable tray/ladder load in kN/m without man load
- 2 Support width in m
- 3 Rail bend in mm at permitted kN/m
- Load curve with cable tray/ladder width in mm
- Strut bend curve according to support width
- 4 Load scheme during testing