

Technical data sheet

Surge arrester V10 Compact 150 V



Item number: 5093378



Surge protective device, compact module, type 2+3

- Surge protection in sub-distributors to VDE 0100-443 (IEC 60364-4-44)
- Arresting capacity up to 60 kA (8/20) in total
- Integrated 3+1 solution for TN and TT network systems on 45 mm module width
- High-performance varistor technology
- Incl. thermal and dynamic cut-off unit and visual function display

Application: Sub/storey distribution as well as device protection in rotational current systems.



Master data

Item number	5093378
Type	V10 COMPACT 150
Description 1	V10 Compact
Manufacturer	OBO
Dimension	150V
Smallest sales unit	1
Unit of quantity	Piece
Weight	15.8 kg
Weight unit	kg/100 pc.

Technical data sheet

Surge arrester V10 Compact 150 V

Item number: 5093378



Technical data

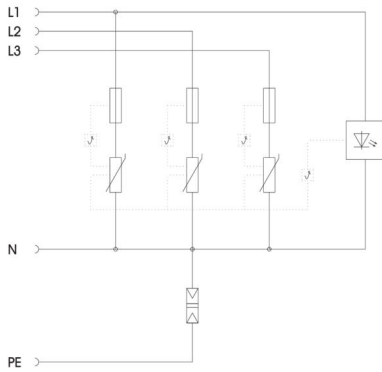

Arrester surge current (8/20 μ s) [total]	60 kA
Response time	<25 ns
Blow-out	no
Version for	3+N/PE
Pole version	3+N/PE
Structural width in division units (division unit, 17.5 mm)	Miscellaneous
Operating temperature, max.	80 °C
Operating temperature, min.	-40 °C
Remote signalling	no
Follow current quenching capacity (eff) [N-PE]	0.1 kA
Follow current quenching capacity left	10
Maximum continuous voltage AC	150
Integrated back-up fuse	no
Conductor cross-section, flexible (fine-wire), min.	10 mm ²
Conductor cross-section, rigid (single-wire/multiwire), max.	10 mm ²
Conductor cross-section, rigid (single-wire/multiwire), min.	2.5 mm ²
Lightning protection zone LPZ	1→3
Max. mains-side overcurrent protection	63
Maximum back-up fuse	63 A
Maximum discharge current (8/20 μ s)	20 kA
Installation type	DIN rail 35 mm
Nominal discharge current (8/20 μ s)	10 kA
Nominal voltage AC (50/60 Hz)	120 V
Network form	Other
TN network form	yes
TN-C-S network form	yes
TN-S network form	yes
TT network form	yes
Test class, type 2	yes
Test class, type 3	yes
Protection rating	IP20
Protection level	$\leq 0,7$
Signalling on device	Visual
SPD to EN 61643-11	Type 2+3
SPD to IEC 61643-1	Class II+III
Cable type for surge protection devices	Power cable AV