

Base / Unterteil V 20-C/U-3PH-Y

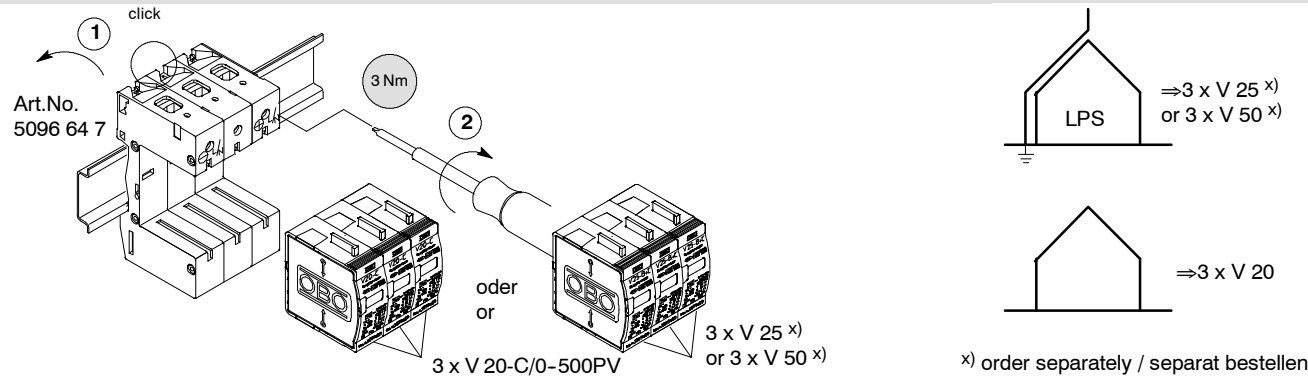

Technical Data / Technische Daten

Typ	V 20-C 0-500 PV	V 20-C 0-300 PV
U_{DC}	500 V	300 V
U_{AC}	440 V	280 V
$U_{OC max}$	1000 V	600 V
LPZ	LPZ 1->2	
U_p	$\leq 2,0$ kV	$\leq 1,3$ kV
$U_{P(+)} (\pm)$	$\leq 4,0$ kV	$\leq 2,6$ kV
$I_n (8/20)$	20 kA	20 kA
$I_{max} (8/20)$	40 kA	40 kA

Typ	V 50-B+C 0-300 PV	V 25-B+C 0-450 PV
U_{DC}	300 V	450 V
U_{AC}	280 V	385 V
$U_{OC max}$	600 V	900 V

	LPZ 0->2	
U_p	$\leq 1,3$ kV	$\leq 1,5$ kV
$U_{P(+)} (\pm)$	$\leq 2,6$ kV	$\leq 3,0$ kV
$I_n (8/20)$	30 kA	30 kA
$I_{max} (8/20)$	50 kA	50 kA
$I_{imp} (10/350)$	12,5 kA	7 kA
v °C	- 40°C - + 80°C	
IP-Code	20	

SPD-base module / Unterteil			
	12,5	12,5	12,5
min. \square L, N, \perp	2,5 mm ²		
max. \square L, N, \perp	25 mm ²	35 mm ²	35 mm ²

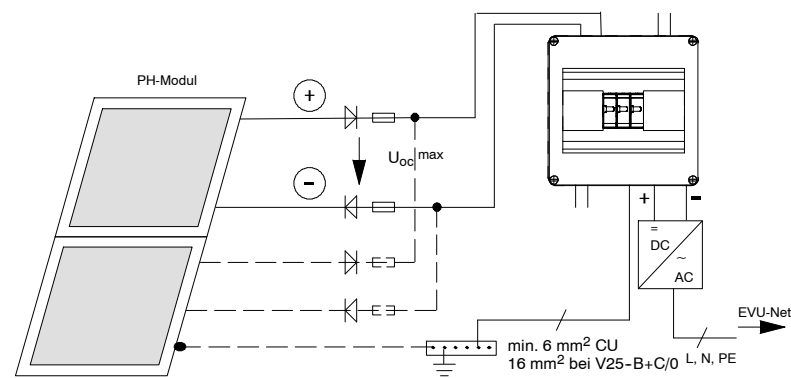
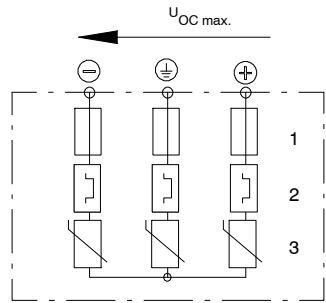

Case / Gehäuse

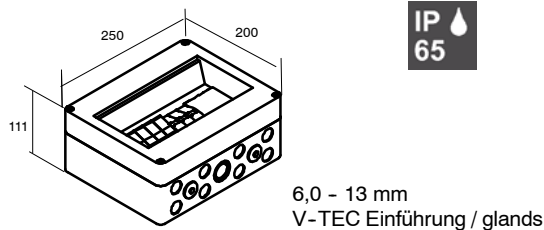

Indication / Signalisierung

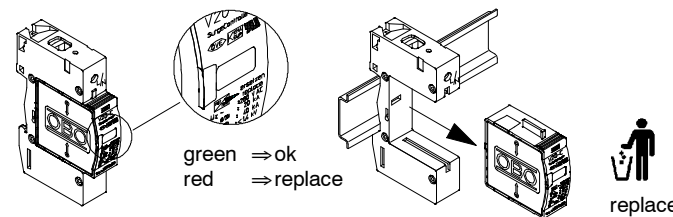

Terminals block / Anschlussklemmen

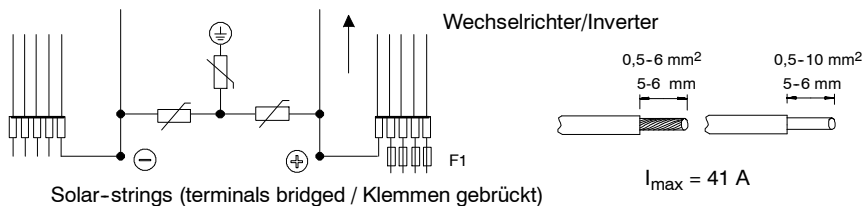

Sicherung / Fuse

Typ: 10 x 38 mm
 $U = 1000$ V DC
 $I = 10$ A

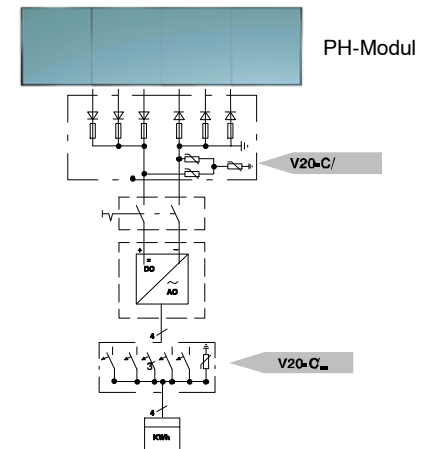

Head Office OBO BETTERMANN GmbH & Co. KG
 Postfach 1120 · 58694 Menden, Germany
 Hüngser Ring 52 · D-58710 Menden
 Tel. +49 (0)2373-89-0 Fax +49 (0)2373-89-238 E-Mail: info@obo.de · www.obo-bettermann.com

Technical Hotline
 Telefon +49 (0)2373/89-1500
 Telefax +49 (0)2373/89-1550
 E-Mail hotline@obo.de